

# evolar

## HEAT PUMP COVER INSTALLATION INSTRUCTIONS

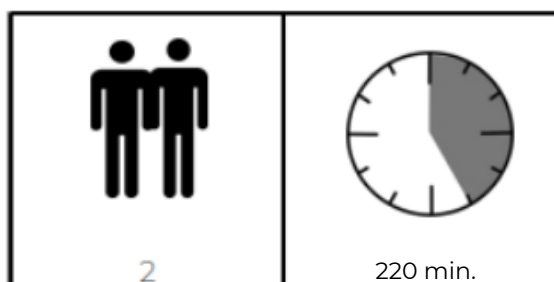

SILENTBOX GAMA SU









### **Evolar**





















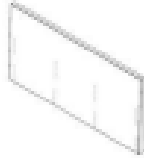



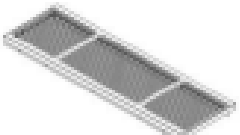

Mercuriusstraat 5  
6541 BM Nijmegen  
The Netherlands

T +31 (0)24 2120369  
[www.evolarshop.com](http://www.evolarshop.com)

TOOLS REQUIRED FOR ASSEMBLY (NOT INCLUDED)

 HAMMER	 TAPE MEASURE	 DRILL	 BORER pr.8x60	 IMBUS 4
 HEADER 8mm	 KNIFE			

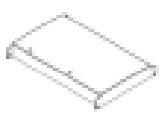
PACKAGE CONTENTS

 142x SCREW M6x16 DIN 7380	 20x SCREW M6x60 DIN 7380	 142x WASHER 6 DIN 125A	 20x WASHER 8 PLAST	 10x TEX 4,8x16
 13x MNA-Z 8x50	 5m DOUBLE-SIDE ADHESIVE TAPE	 18m EPDM SEAL	 2x GAMA SU 1	 2x GAMA SU 2
 2x GAMA SU 6	 2x GAMA SU 8	 2x GAMA SU 9	 1x GAMA SU 60	 2x GAMA SU 13
 1x GAMA SU 14	 2x GAMA SU 15	 2x GAMA SU 16	 2x GAMA SU 18	 1x GAMA SU 19
 1x GAMA SU 23	 1x GAMA SU 21	 1x GAMA SU 22	 1x GAMA SU 61	 2x GAMA SU PHZ
 2x GAMA SU 20	 1x GAMA SU 62	 1x GAMA SU 63		

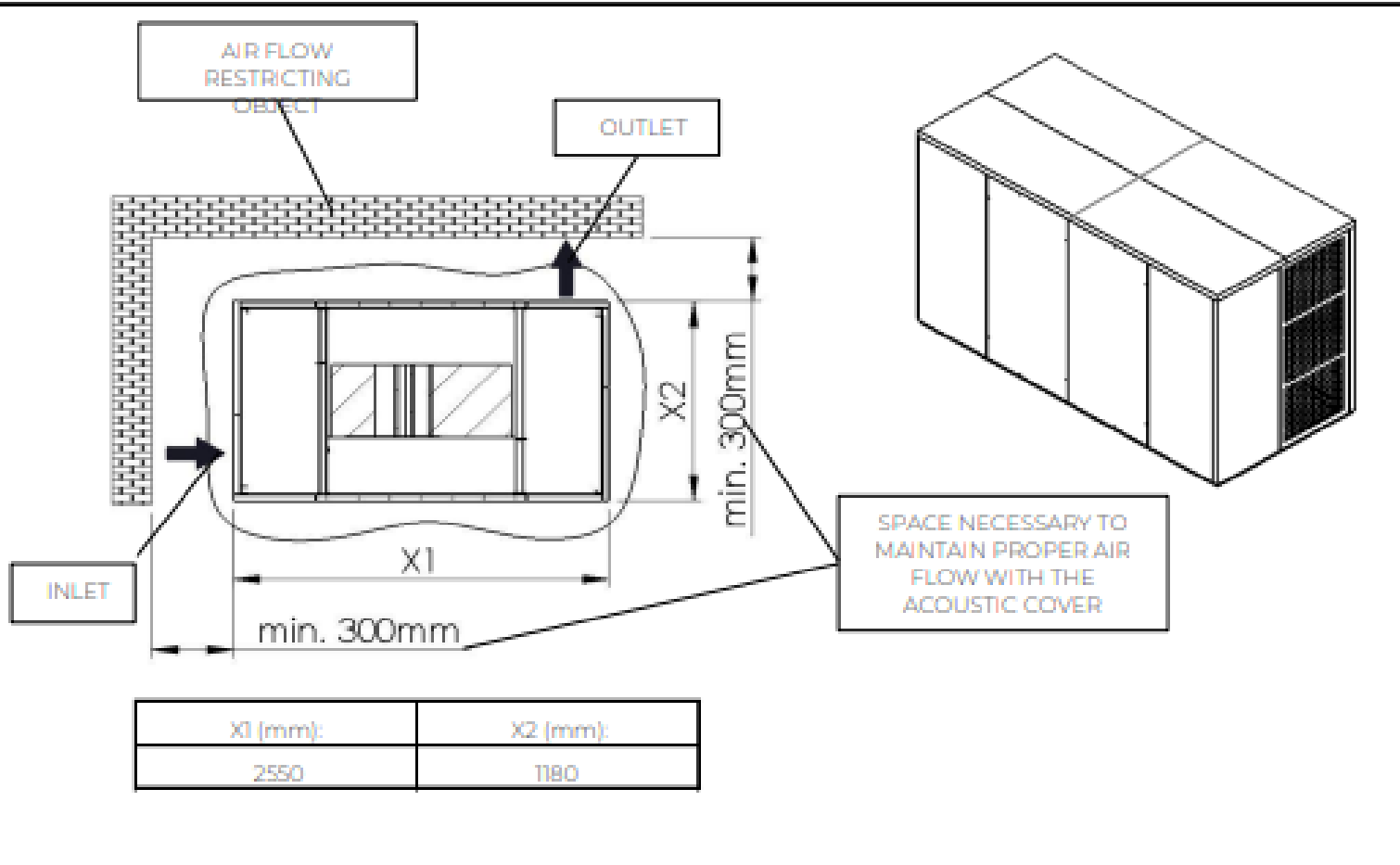

SILENTBOX ACOUSTIC COVER COMBINATION AND DISCHARGE

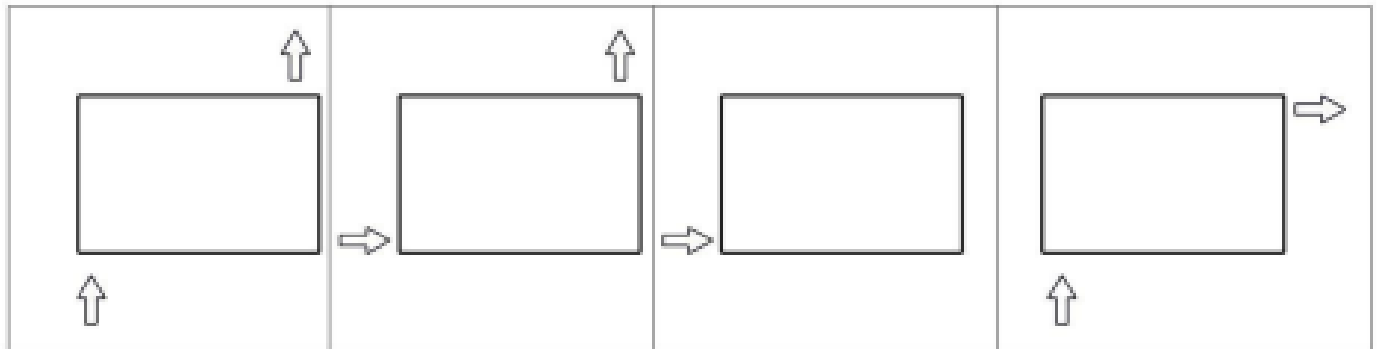

ACOUSTIC COVER DISCHARGE DIRECTION



ACOUSTIC COVER DISCHARGE DIRECTION



ASSEMBLY POINT NO: 31; 32; 33; 34.

ACOUSTIC COVER SUCTION DIRECTION



ASSEMBLY POINT NO: 41; 42; 43; 44.

ACOUSTIC COVER SUCTION DIRECTION



ASSEMBLY POINT NO: 51; 52; 53

ASSEMBLY POINT NO: 61; 62; 63

1.

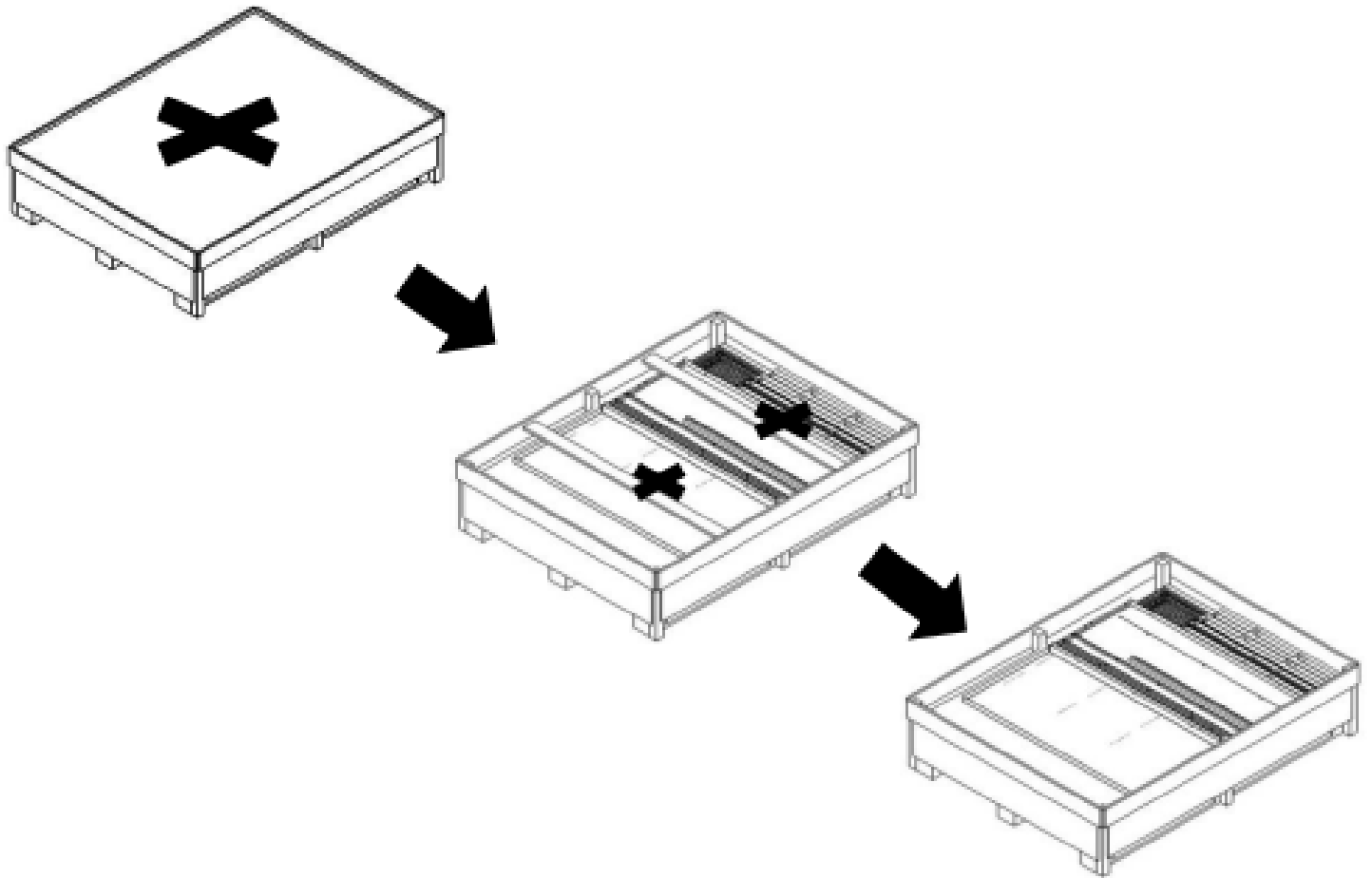

2.



2x

GAMA SU 1



2x

GAMA SU 2



TAPE MEASURE



HAMMER



BORER pr.8x60



DRILL



IMBUS 4



13x

MNA-Z 8x50



12x

SCREW M6x16 DIN 7380



2x

GAMA SU 6



12x

WASHER 6 DIN 125A

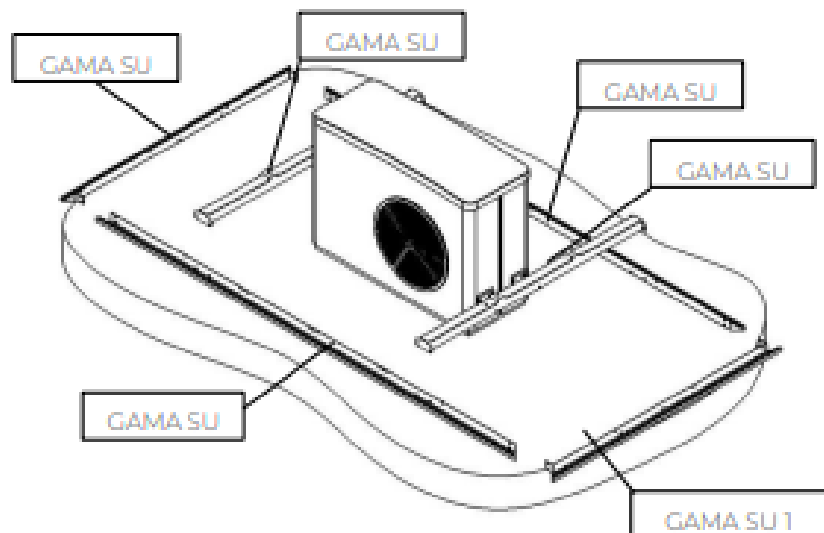
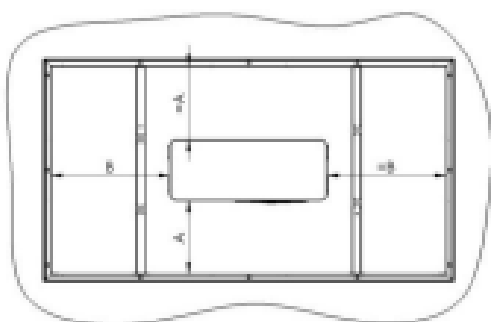

21.

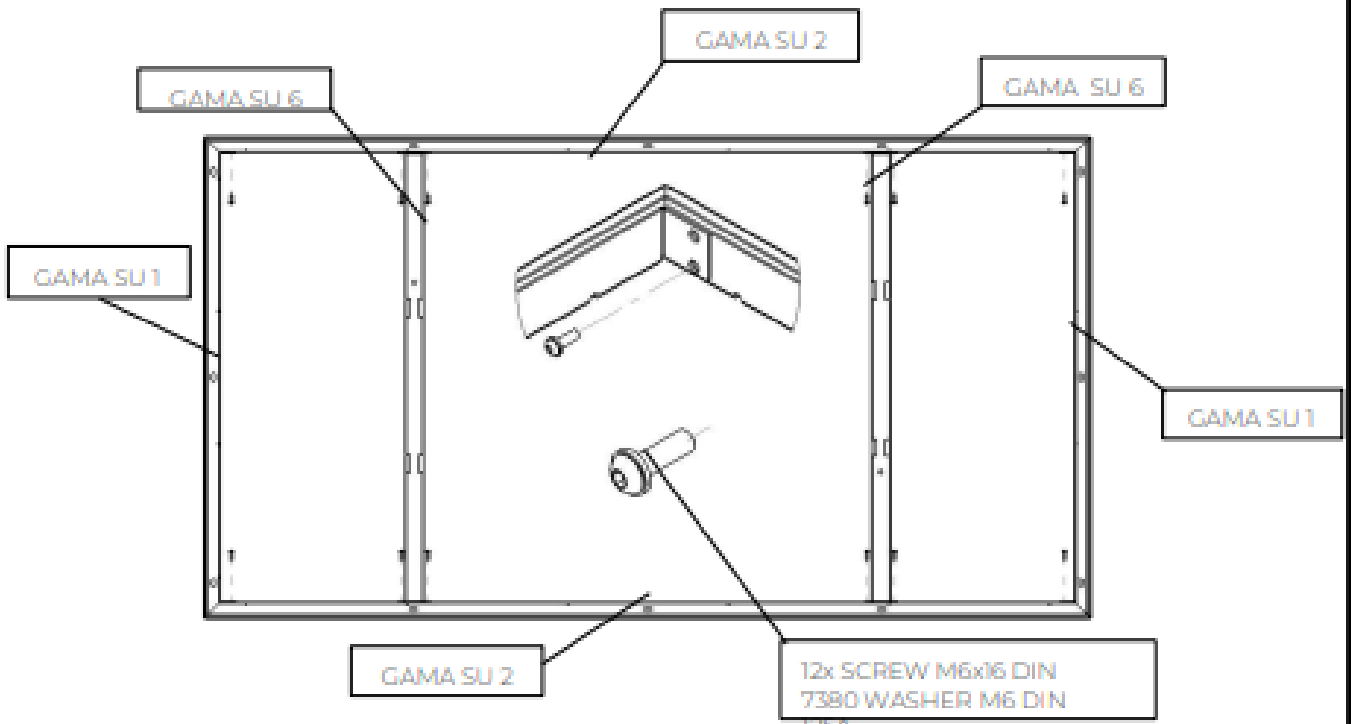



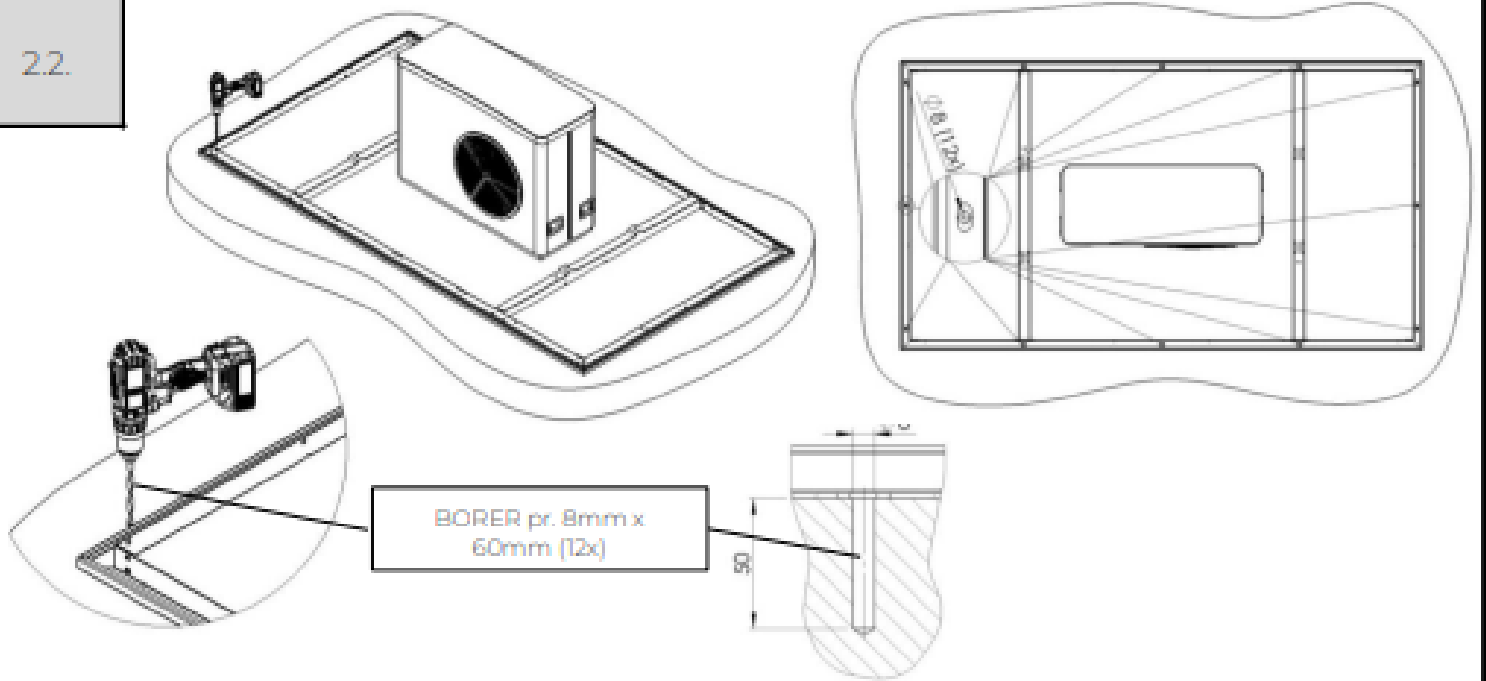

22.

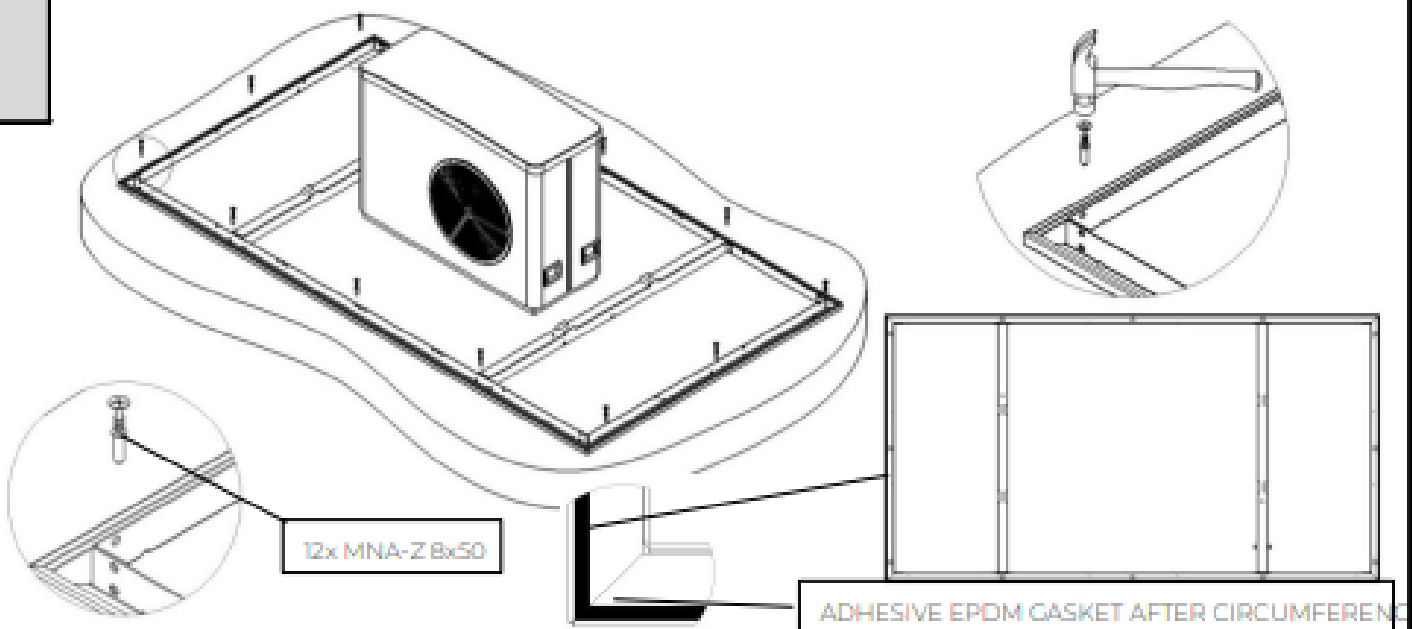

23.







3.1.		 1x	 1x	 1x
	<b>DIRECTION OUTLET</b>	GAMA SU 9	GAMA SU 15	GAMA SU 16

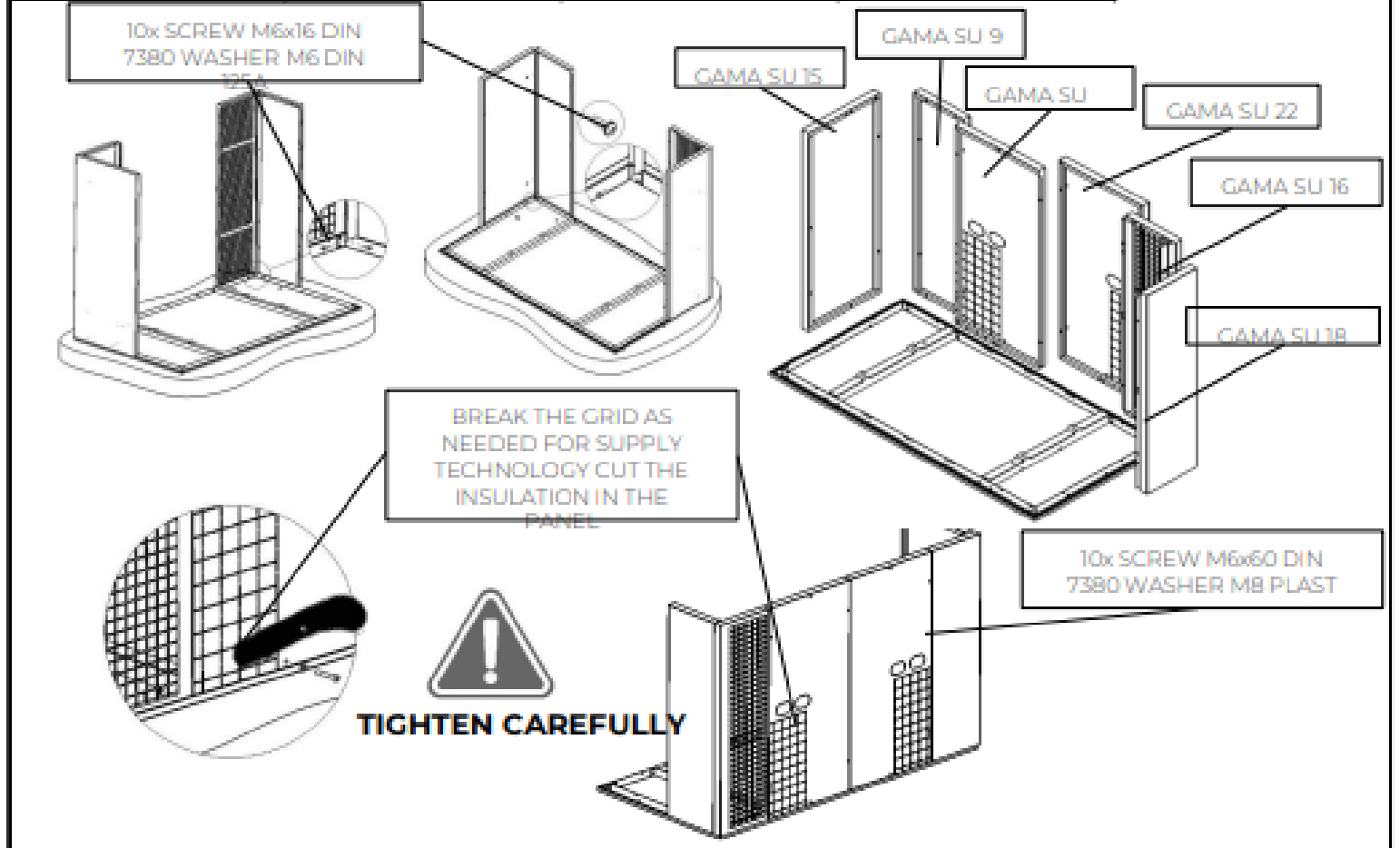



 1x	 1x	 10x	 10x	
---	--	---	---	---

GAMA SU 18	GAMA SU 21	SCREW M6x16 DIN 7380	WASHER 6 DIN 125A	IMBUS 4
 10x	 10x		 1x	
SCREW M6x60 DIN 7380	WASHER 8 PLAST	KNIFE	GAMA SU 22	

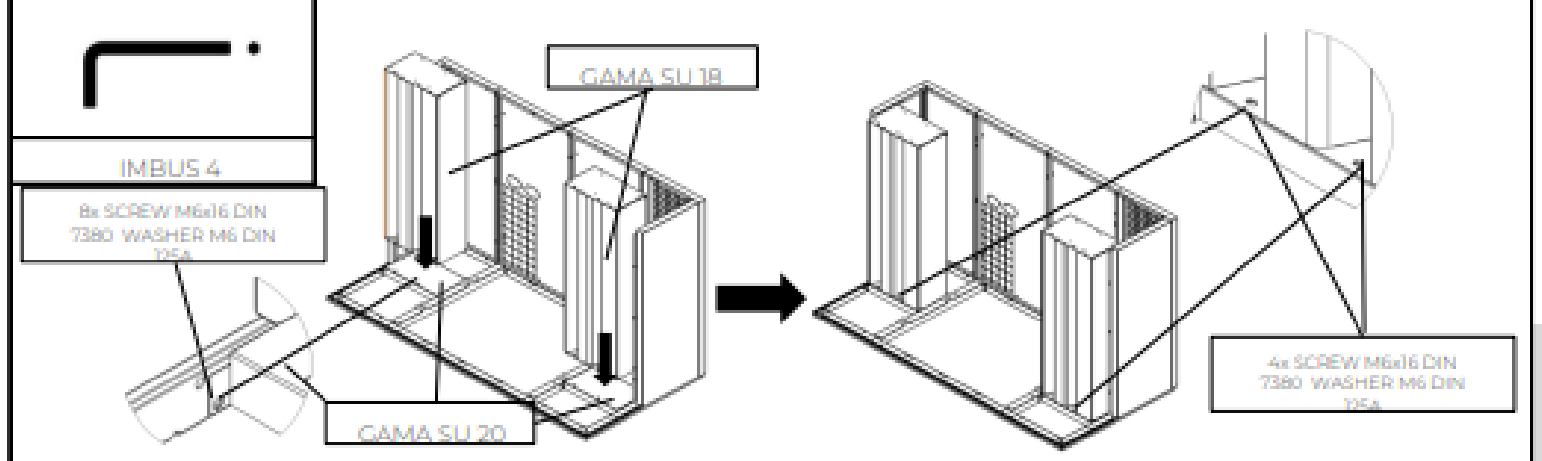





3.2.	 12x	 12x	 2x	 2x
	SCREW M6x16 DIN 7380	WASHER 6 DIN 125A	GAMA SU PHZ	GAMA SU 20

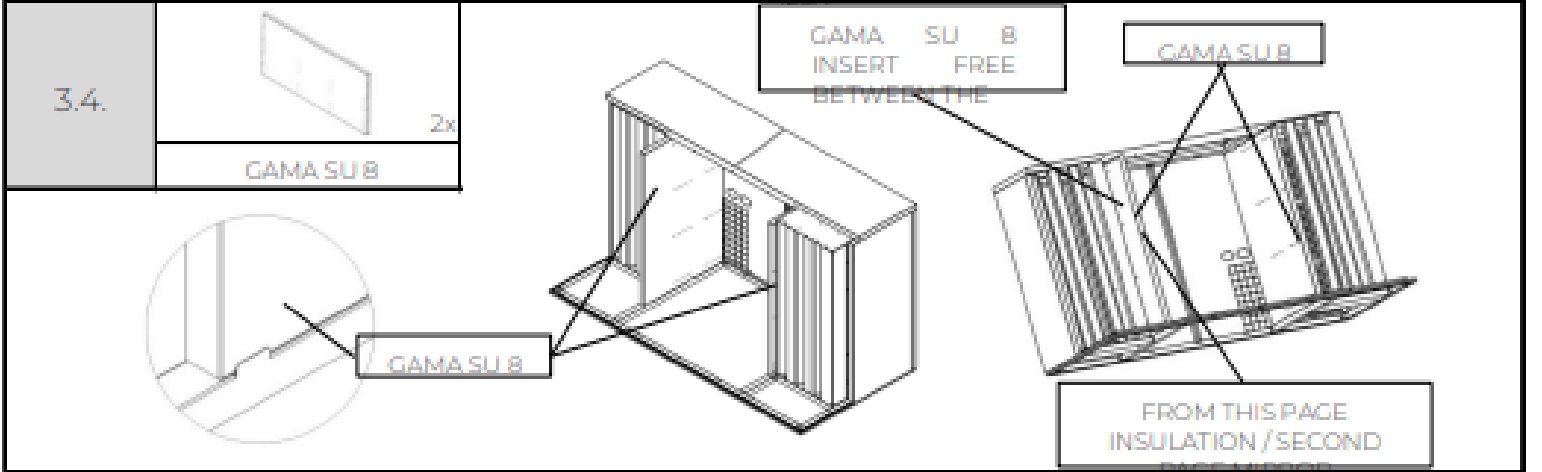
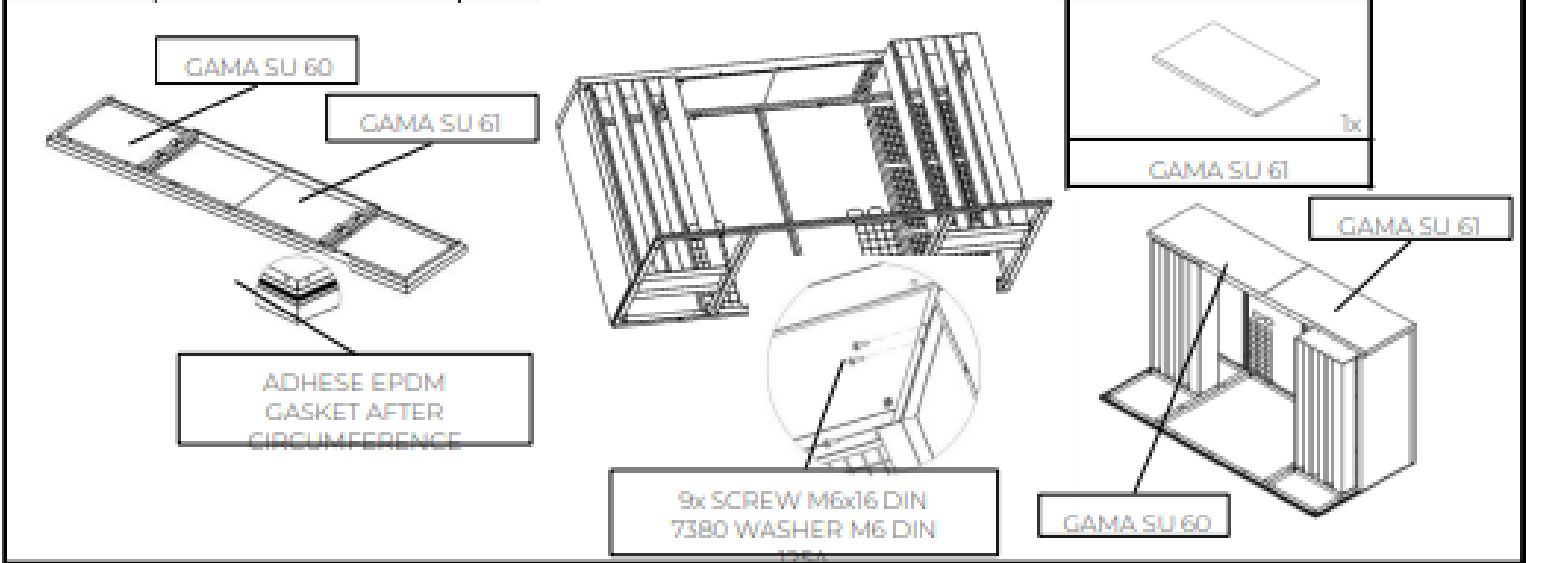

3.3.	 1x	 9x	 9x	
	GAMA SU 60	SCREW M6x16 DIN 7380	WASHER 6 DIN 125A	IMBUS 4



4.1.		 1x	 1x	 1x
	DIRECTION OUTLET	GAMA SU 9	GAMA SU 15	GAMA SU 16

 1x	 1x	 1x	 10x	
GAMA SU 18	GAMA SU 21	GAMA SU 22	WASHER 6 DIN 125A	IMBUS 4
 10x	 10x	 10x		
SCREW M6x60 DIN 7380	WASHER 8 PLAST	SCREW M6x16 DIN 7380	KNIFE	GAMA SU 21

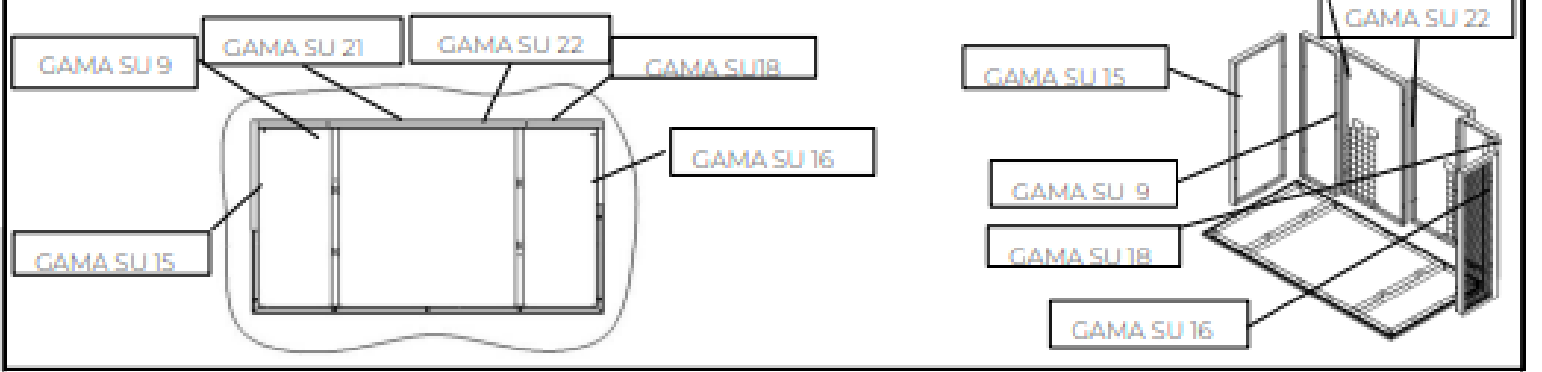

4.1.

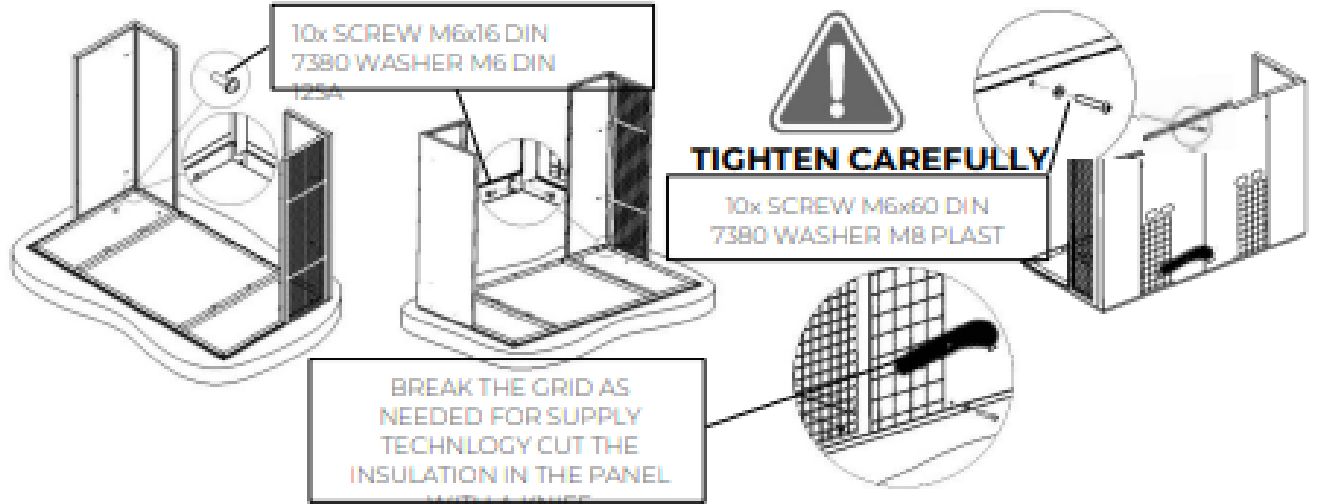

4.2.

12x	12x	2x	2x
SCREW M6x16 DIN 7380	WASHER 6 DIN 125A	GAMA SU PHZ	GAMA SU 20



IMBUS 4

8x SCREW M6x16 DIN 7380 WASHER M6 DIN 125A

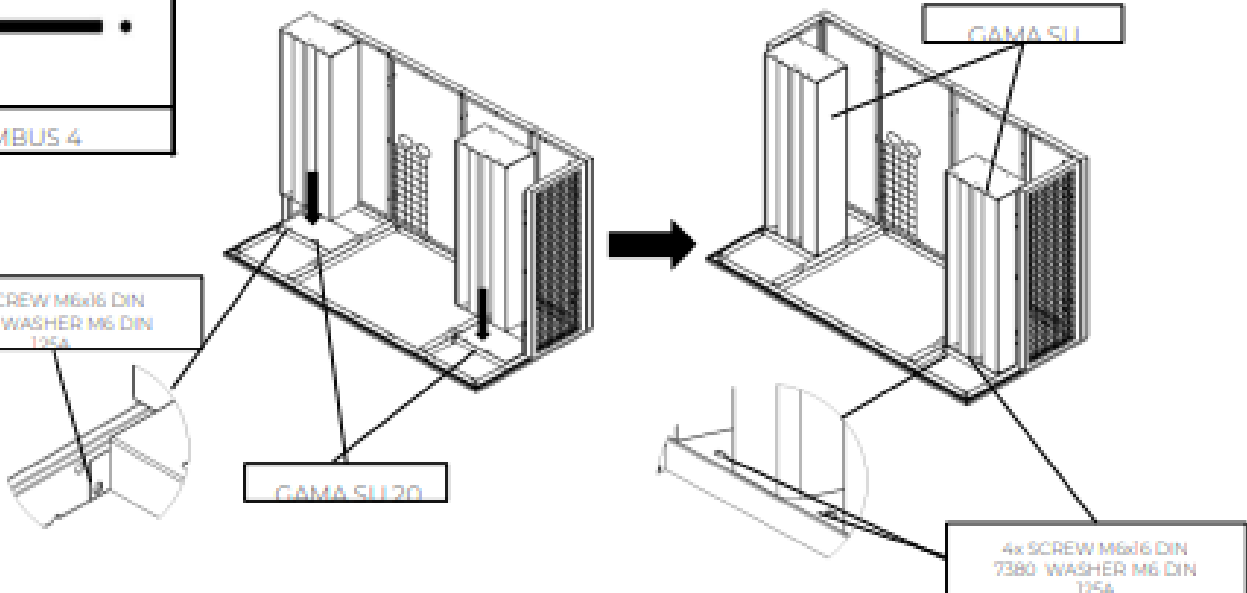

4.3.

1x	9x	9x	
GAMA SU 60	SCREW M6x16 DIN 7380	WASHER 6 DIN 125A	IMBUS 4

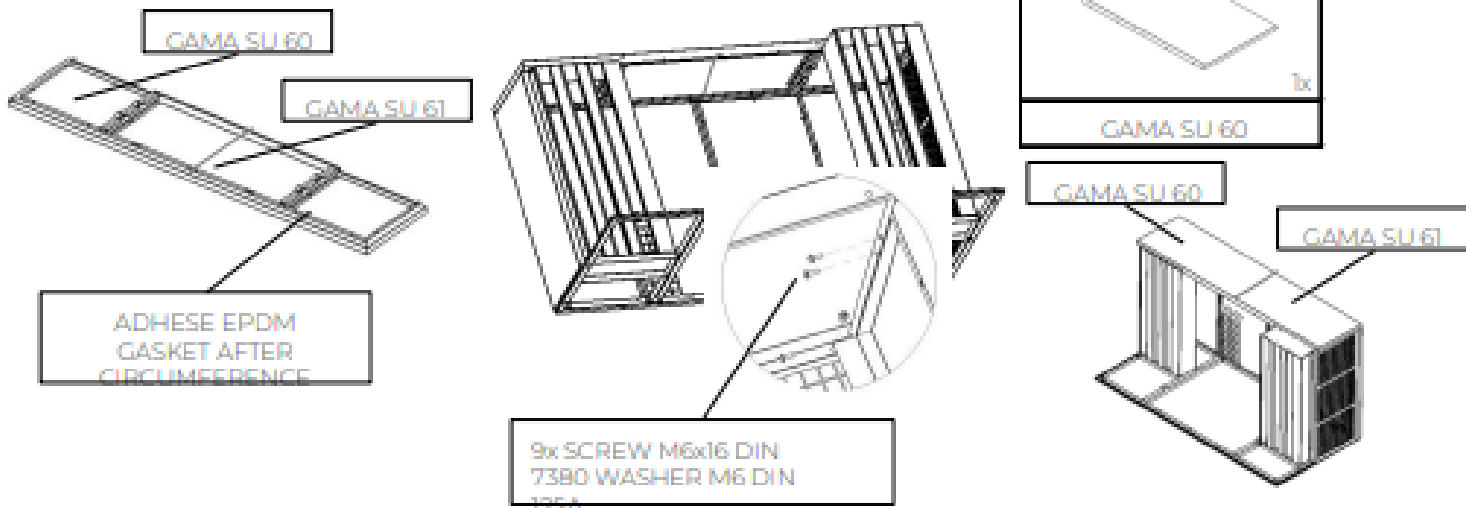



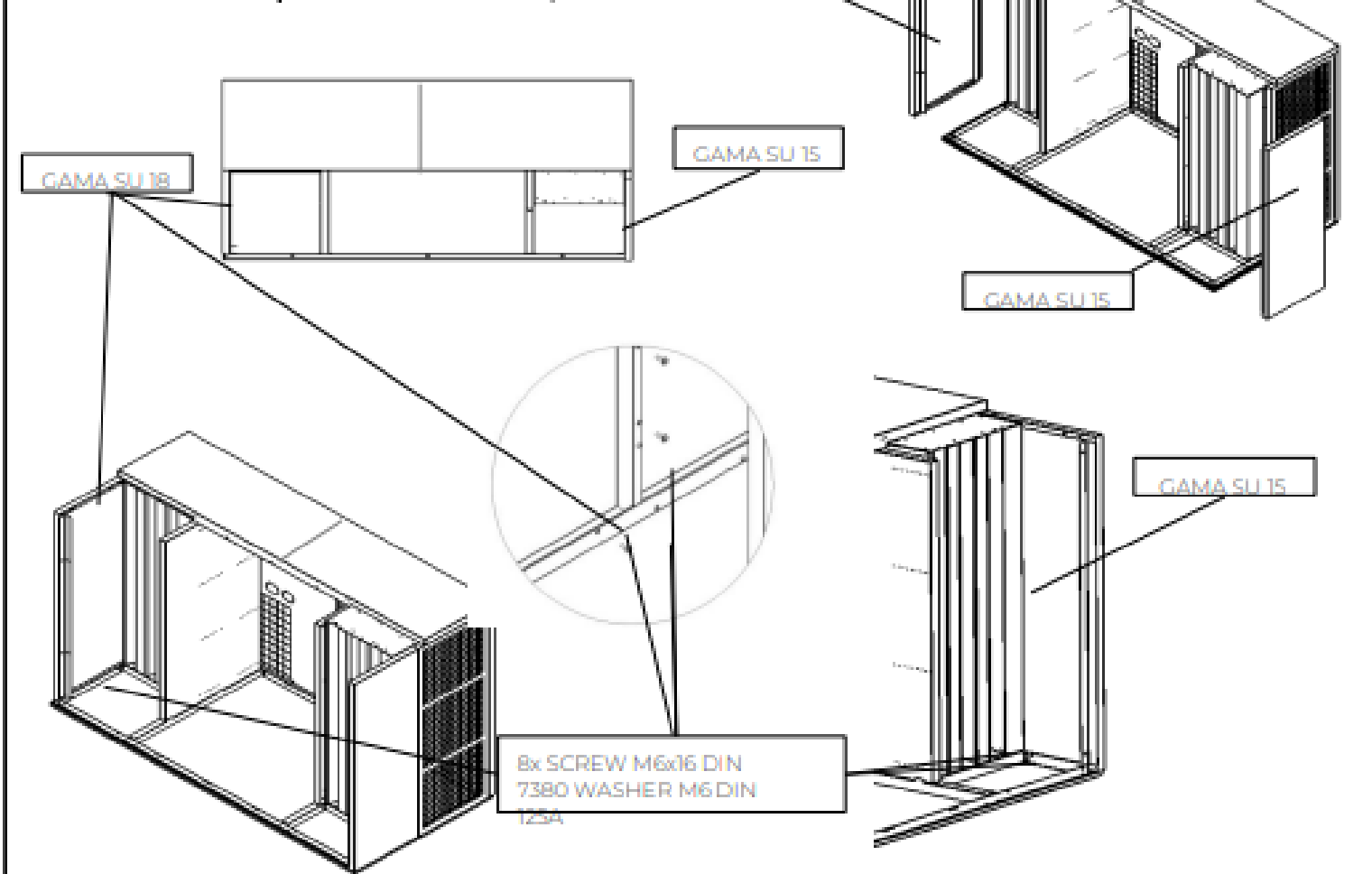
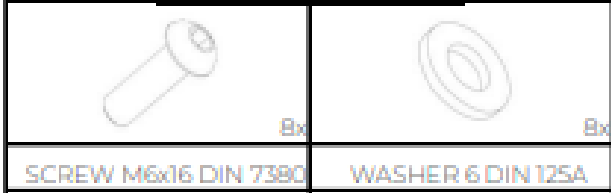
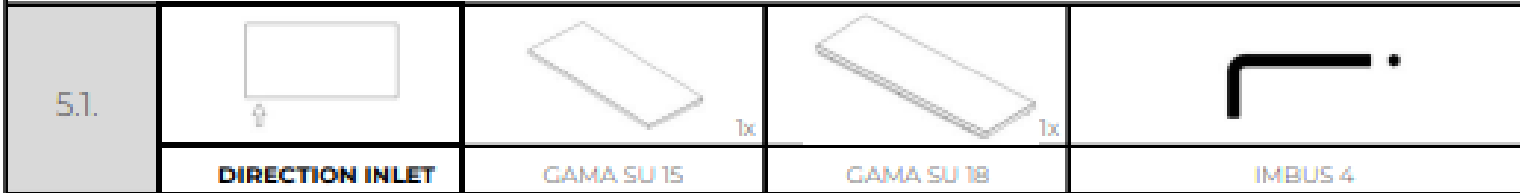
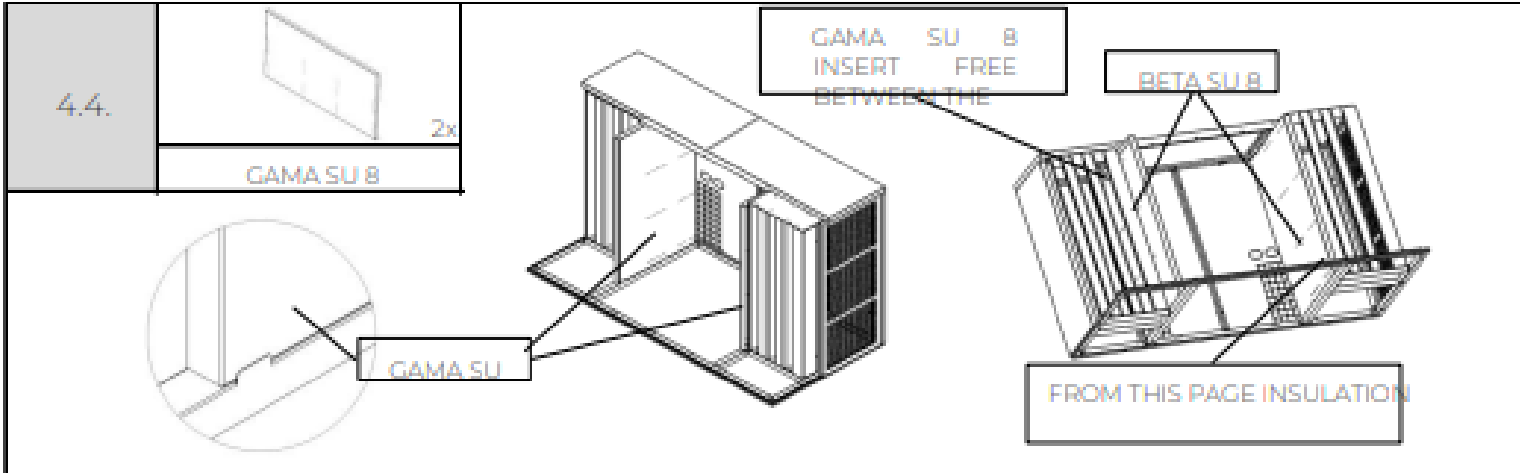

5.2.



1x



12x



12x



GAMA SU 9

SCREW M6x16 DIN 7380

WASHER 6 DIN 125A

IMBUS 4



1x



1x

GAMA SU 16

GAMA SU 59

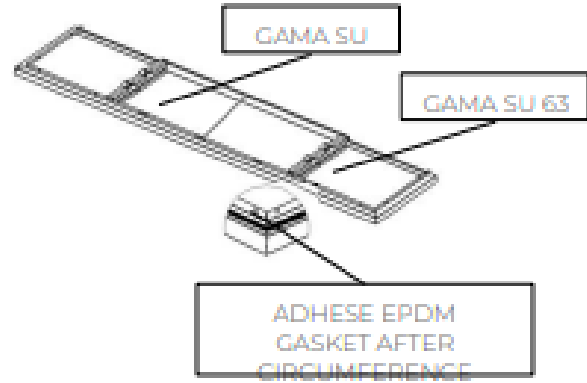

GAMA SU

GAMA SU 63

ADHESE EPDM  
GASKET AFTER  
CIRCUMFERENCE

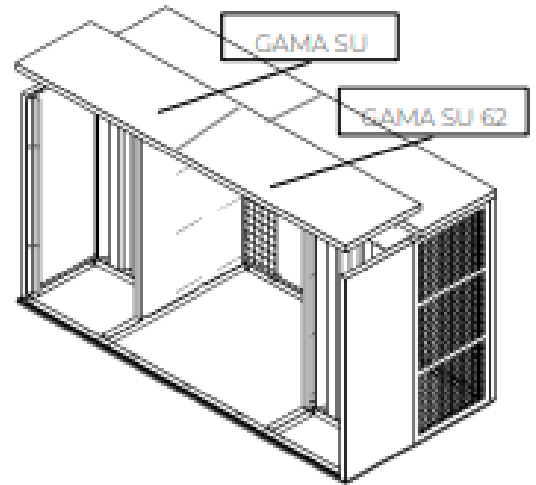

GAMA SU

GAMA SU 62

12x SCREW M6x16 DIN  
7380 WASHER M6 DIN

GAMA SU 16

GAMA SU 9

GAMA SU

GAMA SU 9

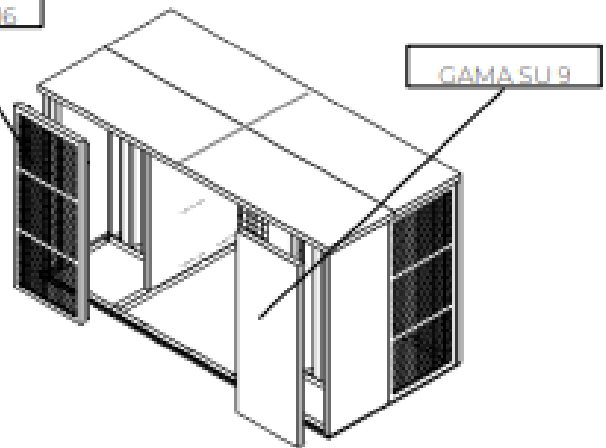
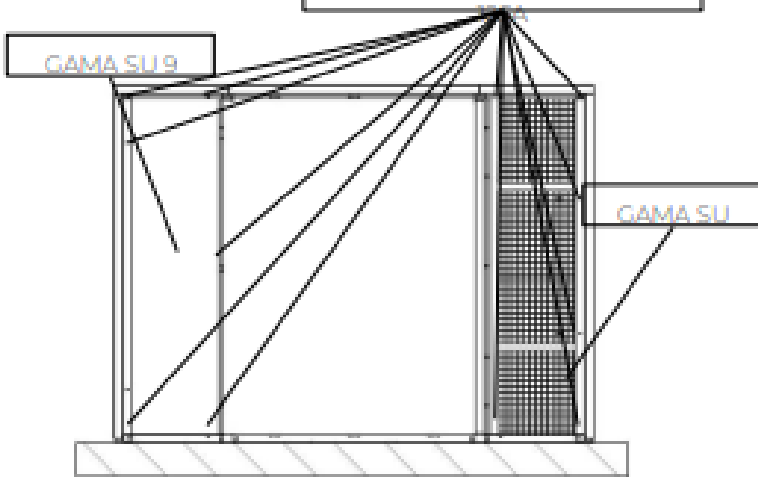

5.3.

GAMA SU 8 SLIDE TO  
THE FRONT SERVICE  
DOOR

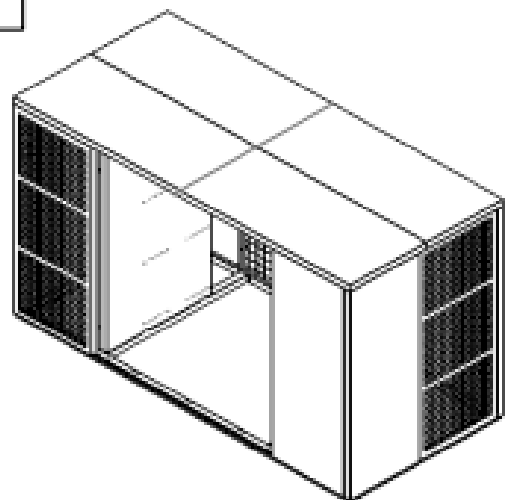
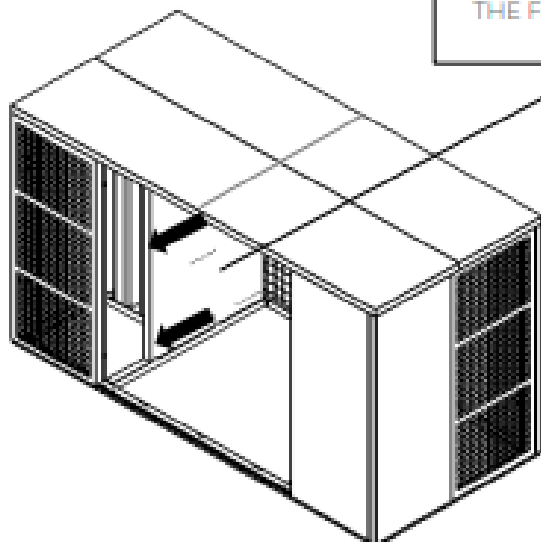

6.1.

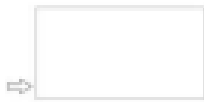

**DIRECTION INLET**



1x

GAMA SU 16



1x

GAMA SU 15



IMBUS 4



8x

SCREW M6x16 DIN 7380



8x

WASHER 6 DIN 125A

GAMA SU 16

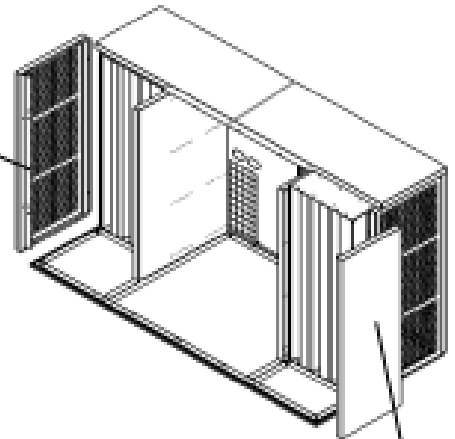

GAMA SU 15

GAMA SU 16

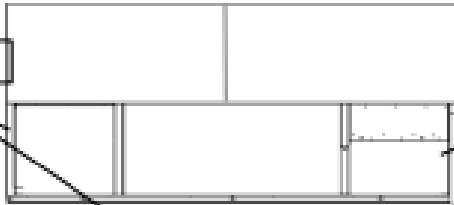

GAMA SU 15

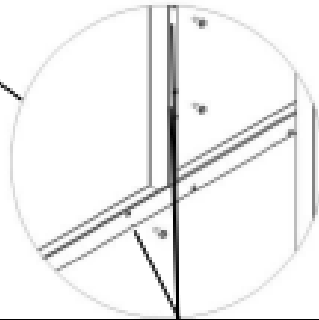
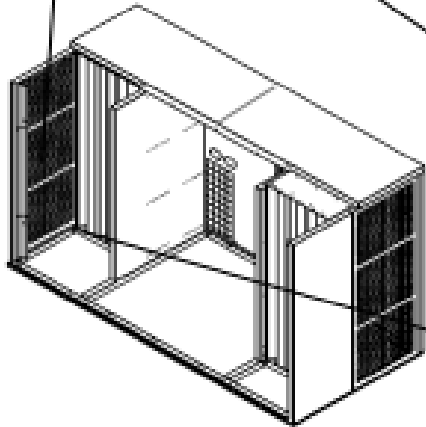

8x SCREW M6x16 DIN 7380  
WASHER M6 DIN 125A

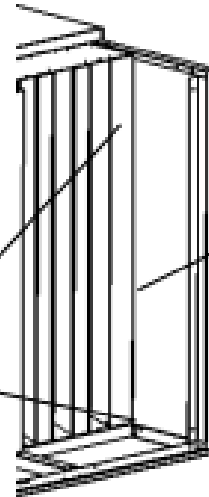

GAMA SU 15

6.2.

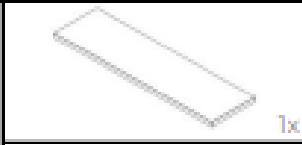

GAMA SU 9

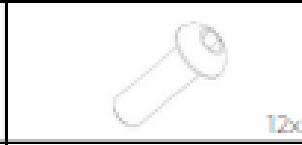

SCREW M6x16 DIN 7380

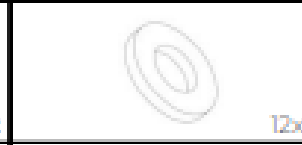

WASHER 6 DIN 125A

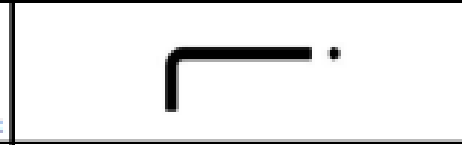

IMBUS 4



GAMA SU 18

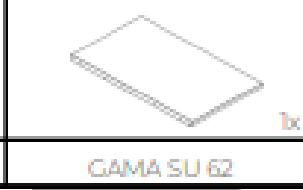

GAMA SU 62



GAMA SU 63

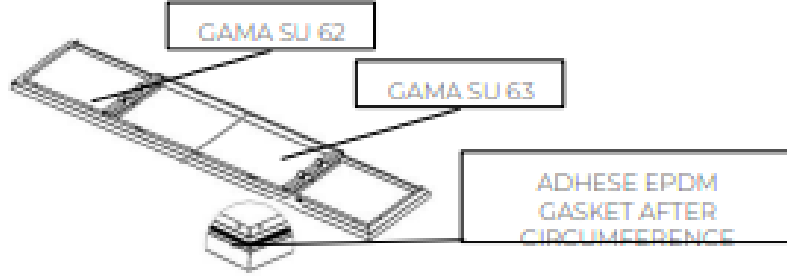
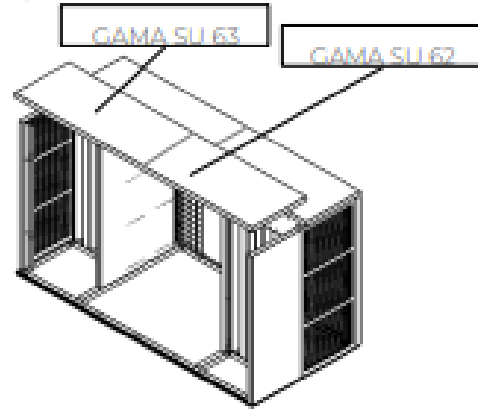

13x SCREW M6x16 DIN 7380 WASHER M6 DIN 125A

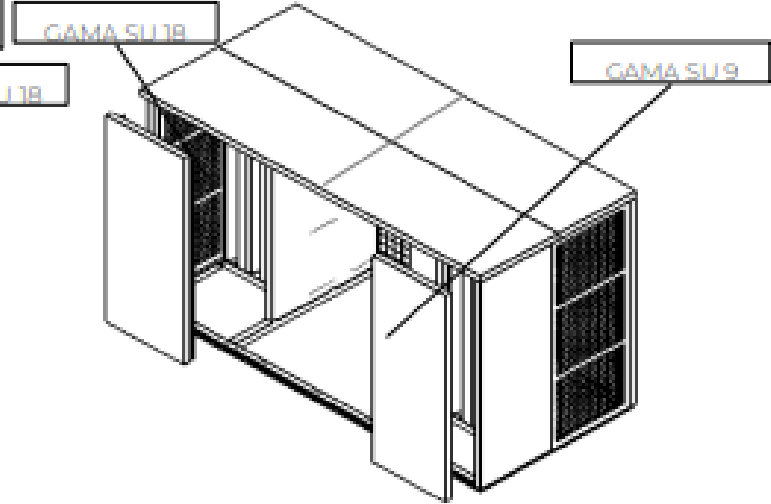
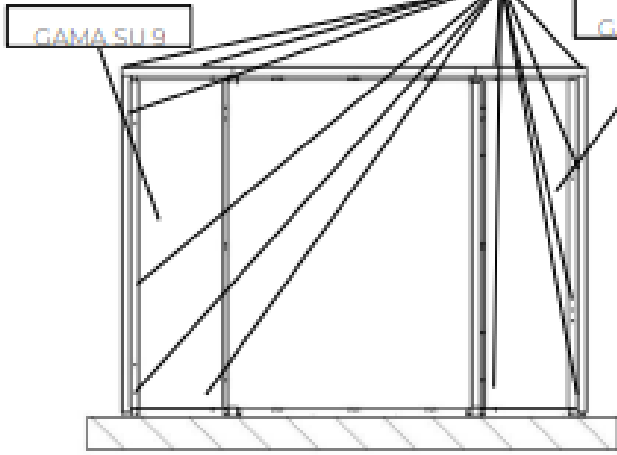

6.3.

GAMA SU 8 MOVE TO FRONT SERVICE DOOR

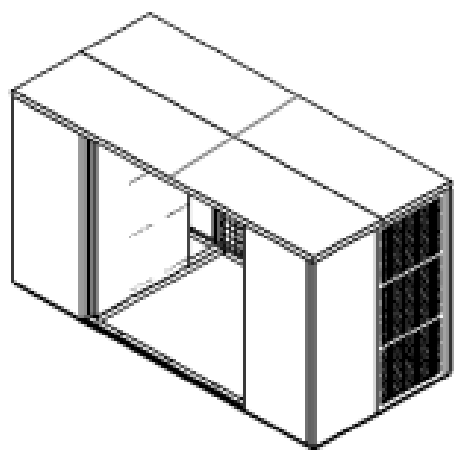
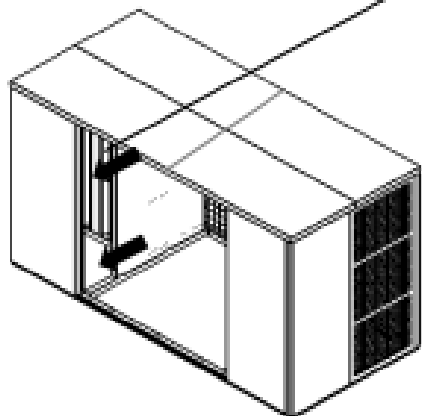

7.1.

 2x	 8x	
GAMA SU 13	TEX 4,8x16	HEADER 8mm

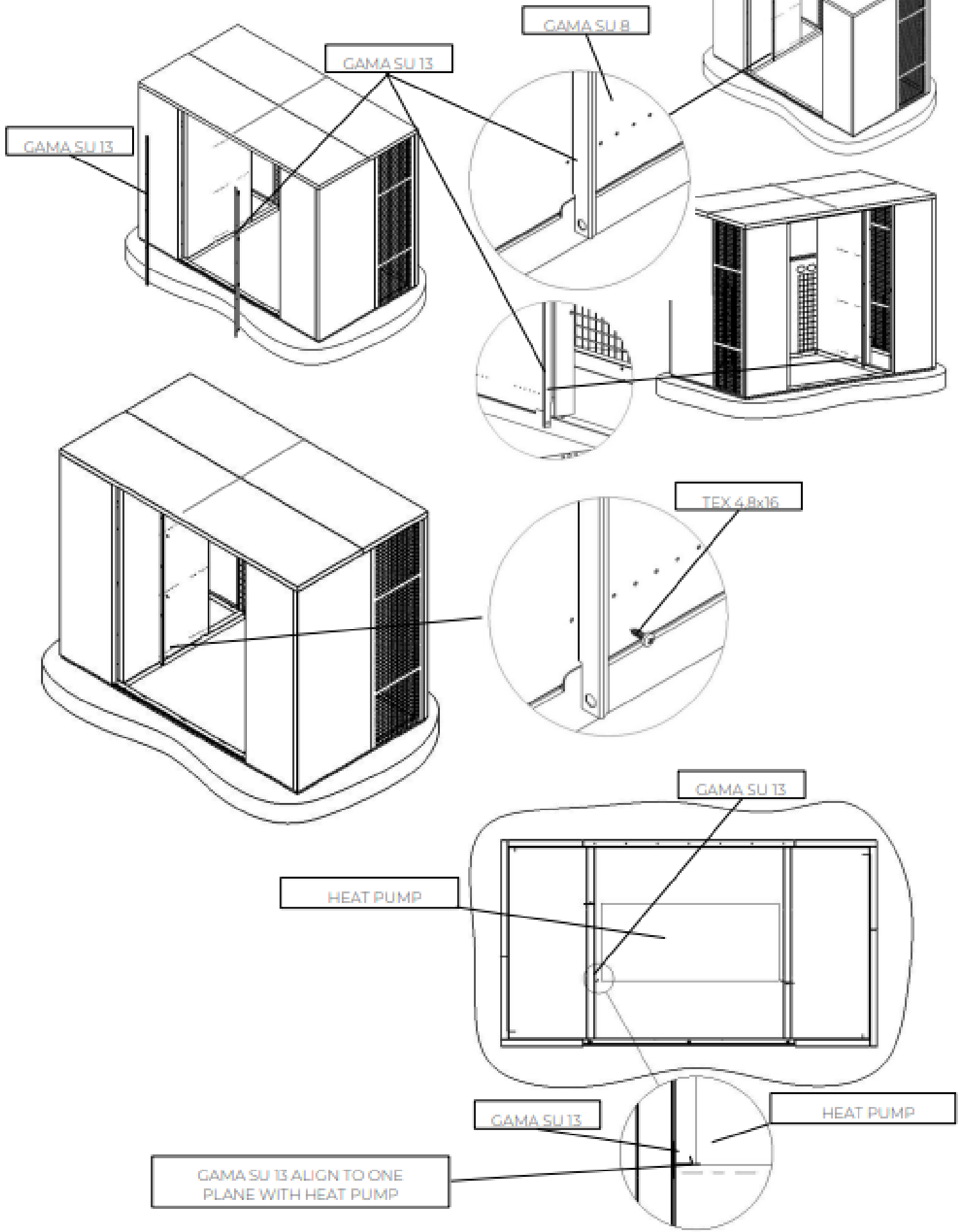

7.2



1x

GAMA SU 14



10x

SCREW M6x16 DIN 7380



10x

WASHER 6 DIN 125A



IMBUS 4



KNIFE

10x SCREW M6x16  
DIN 7380  
WASHER 6 DIN  
125A

GAMA SU 14

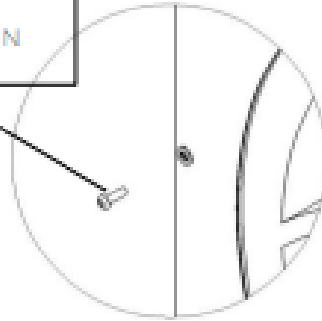
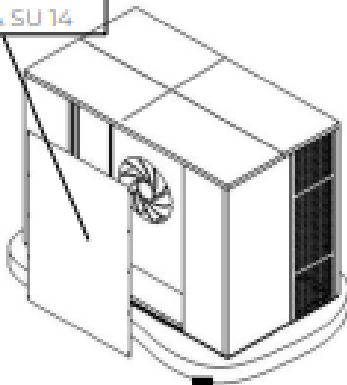

REMOVE PART  
GAMA SU 14 AND  
FAN ENCLOSURE  
WITH DOUBLE-SIDE  
ADHESIVE TAPE

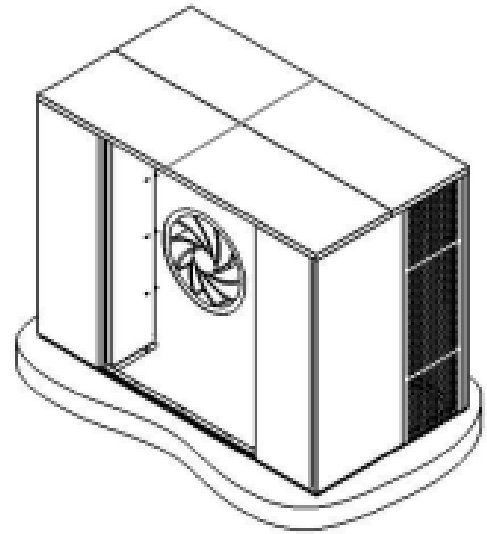

TO PART GAMA  
SU 14 CUT  
FACE SHAPE  
ON HEAT

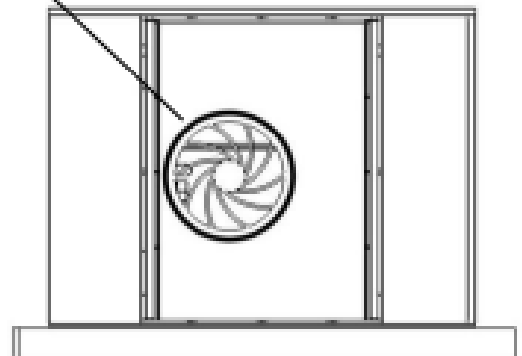
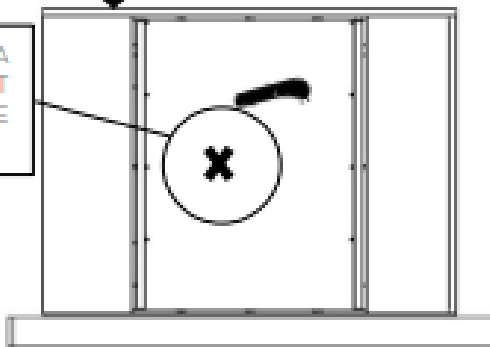

7.3.



1x

GAMA SU 19



10x

SCREW M6x60 DIN 7380



10x

WASHER 8 PLAST



IMBUS 4



1x

GAMA SU 23

GAMA SU 23

GAMA SU

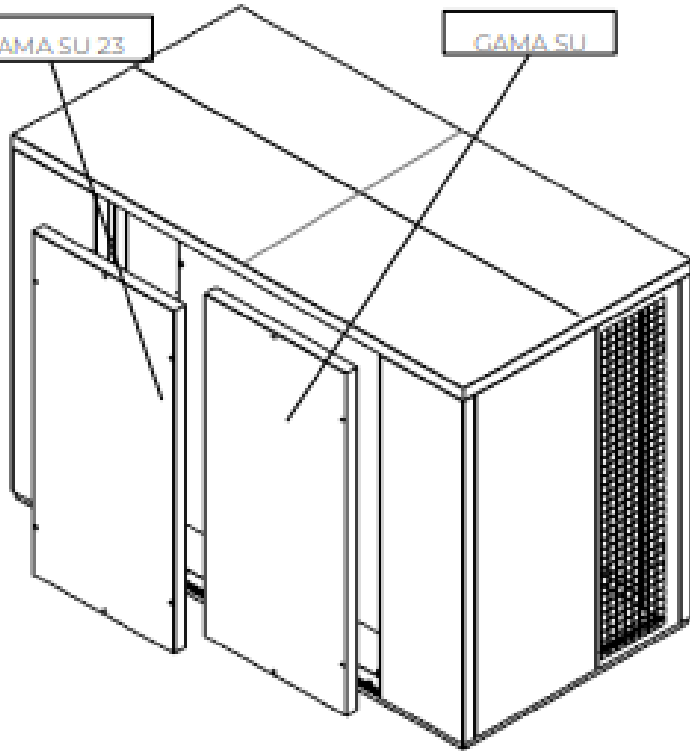

10x SCREW M6x60 DIN  
7380 WASHER 8B PLAST



**TIGHTEN CAREFULLY**

